

Product Specification

Brigade Model Number: BE-801C(78)

Brigade Stock Code: #2084A

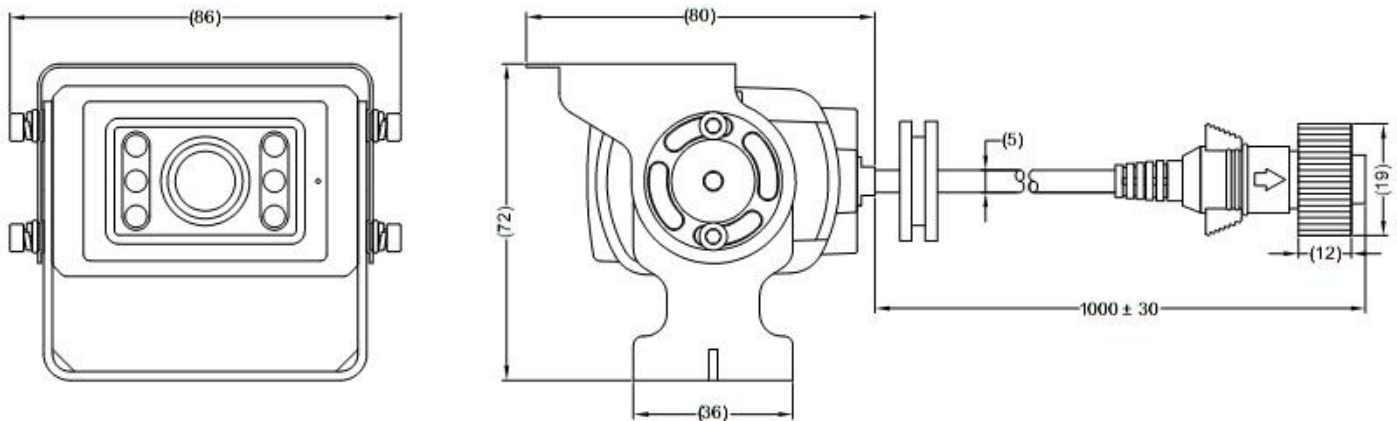

Dimensions: mm

Product Specification

Environmental Specifications:

- Shock Rating: 100 G
- Vibration Rating: 20 G
- Camera IP Rating: IP68
- Connector IP Rating: IP67
- Operating Temperature: -30° to +80°C
- Storage Temperature: -40° to +90°C

Approved Standards:

- CE
- RoHS
- WEEE
- (2006/28/EC) e Marking
- HALT
- (ISO 20653: 2006) IP Testing

Technical Specifications:

- Operating Voltage: 12 Vdc
- Current Consumption: 330mA
- Power Consumption: ≤4.0 Watts
- Imaging Devices: CCD - 1/3" SONY
DSP - SONY
- TV System: NTSC
- Picture Elements: 510 (H) x 492 (V)
- Visual Resolution: 380 TV Lines
- Signal to Noise Ratio: Better than 47dB
- Required Illumination: 0 Lux (IR LED's ON)
- Illumination Distance: 5 Meters

Technical Specifications Continued...

- Video Output: 1.0 Vp-p / 75Ω
- Viewing Angle: 64° (H), 47° (V), 78° (D)
- Weight: Approx. 350 Grams
- Length of Cable: 1000mm ± 30
- Overall Dimensions: 86mm (W) x 80mm (D) x 72mm (H)
- Casing Material: Die cast Aluminium
- View: Mirror/Normal
- Finish: Black Sand Coating

Features:

- Back Light Compensation
- Automatic White Balance
- Automatic IRIS
- 5x High Power Infrared LEDs
- 1x Day/Night Sensor (CDS)
- Integrated Heater (<+10°C)
- BE Type Connector
- High Quality SONY CCD & DSP

Package Contents:

- 1 x (BE-801C(78)-C) Camera
- 1 x (BE-X0XC-BKT) Bracket
- 1 x (BE-X0XC-SS) Sunshield
- 1 x (BE-8XXC-FIX) Fixing Pack
- 1 x (BE-X0XC-IG) Instruction Guide